

KEY MAP

FERNBANK AVE

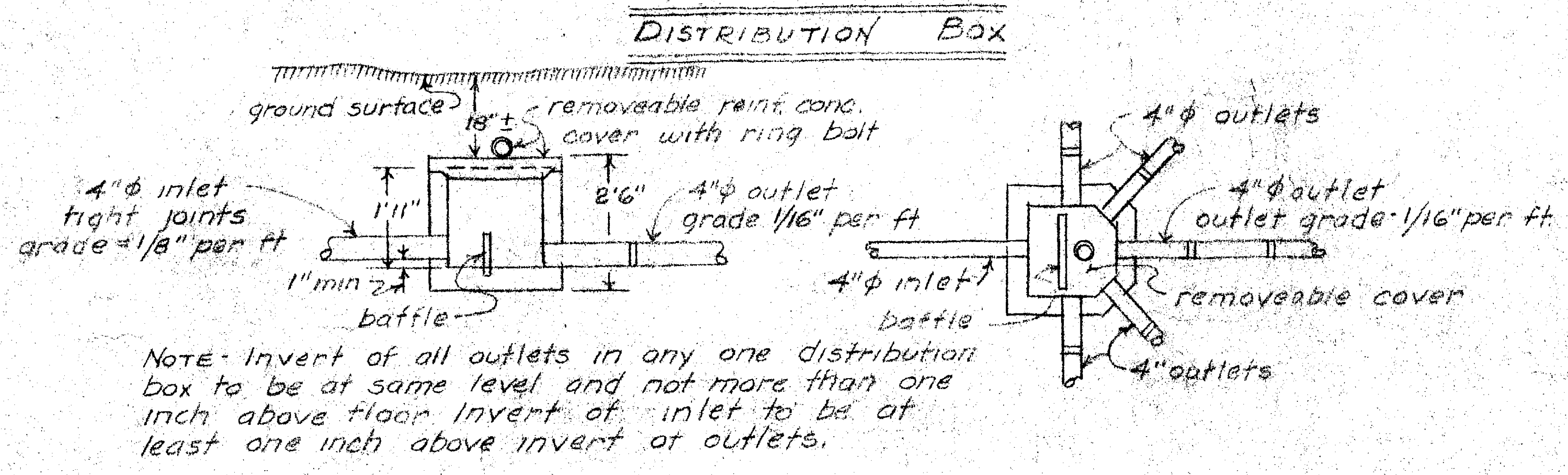
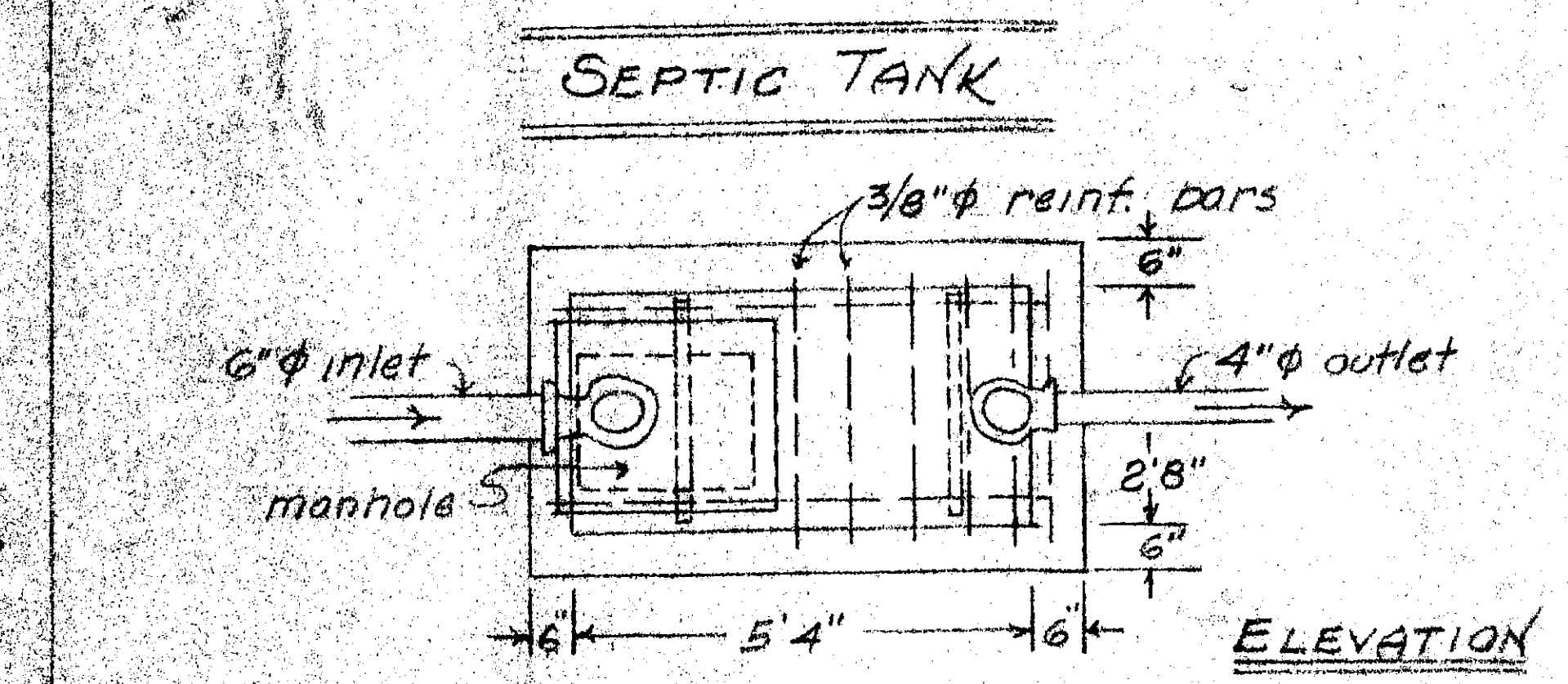
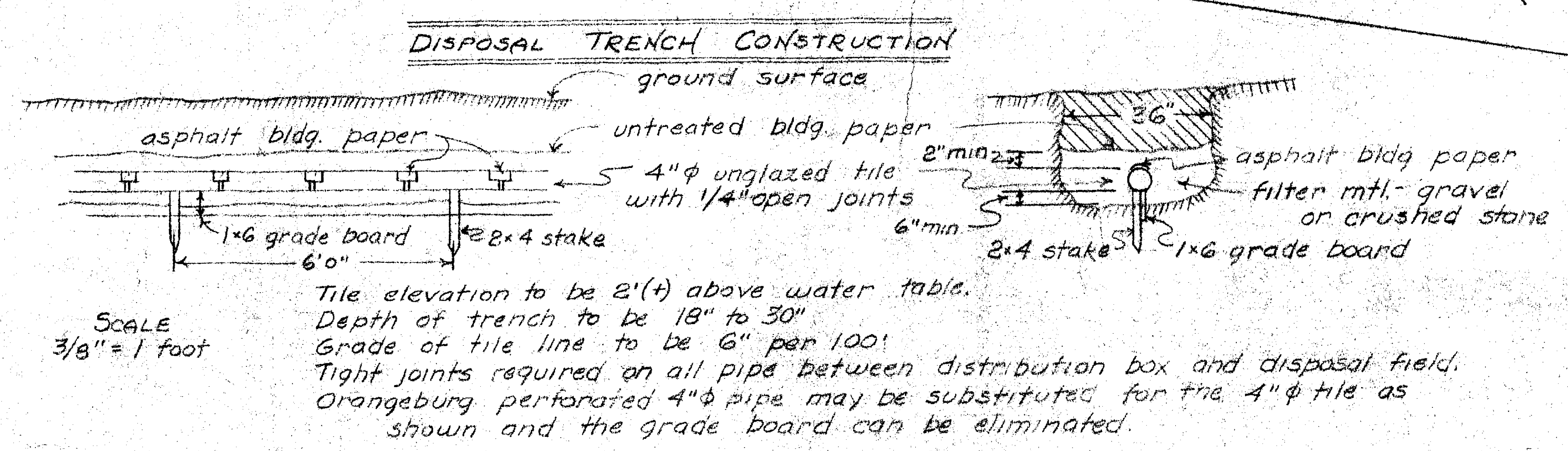
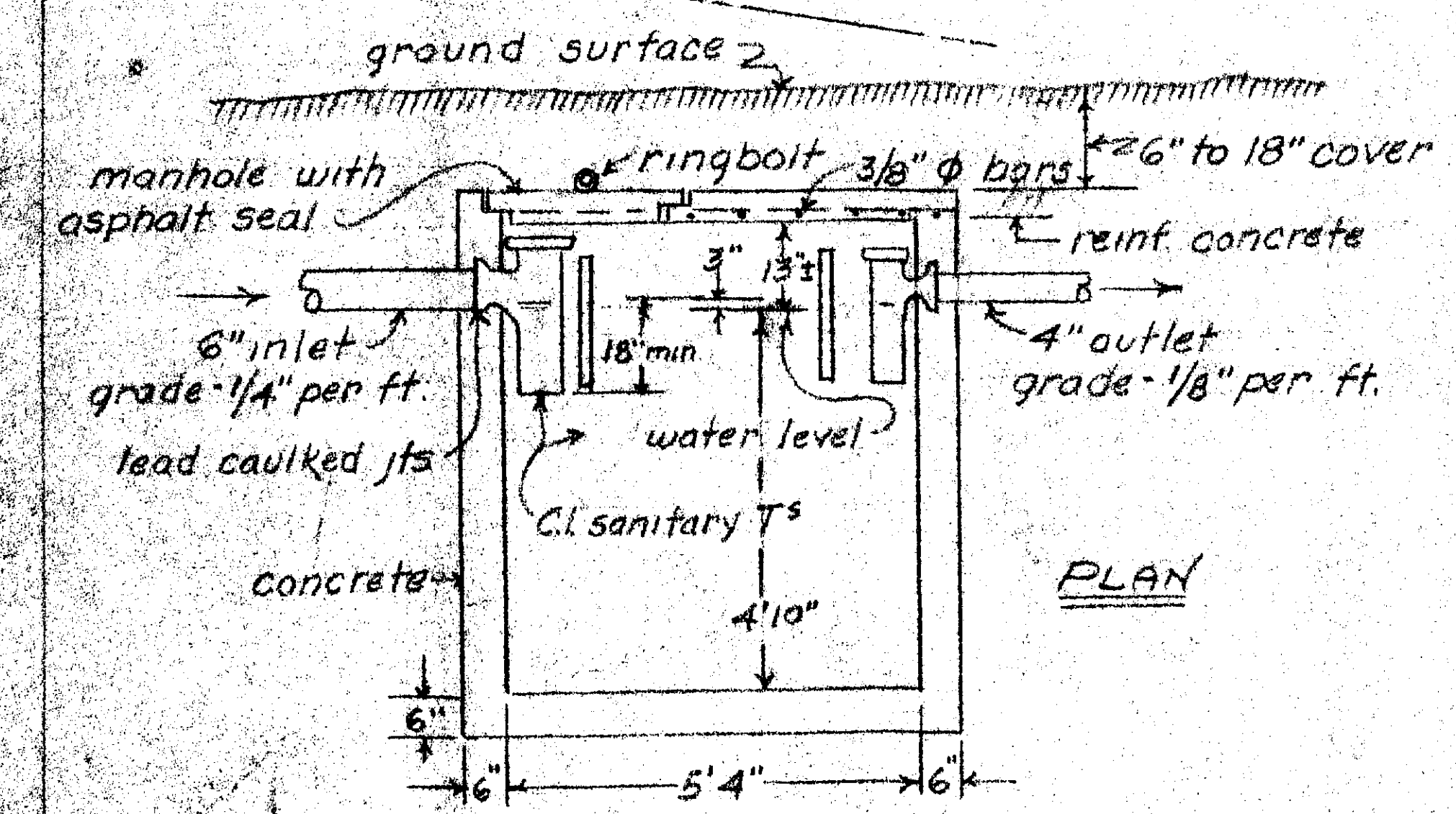
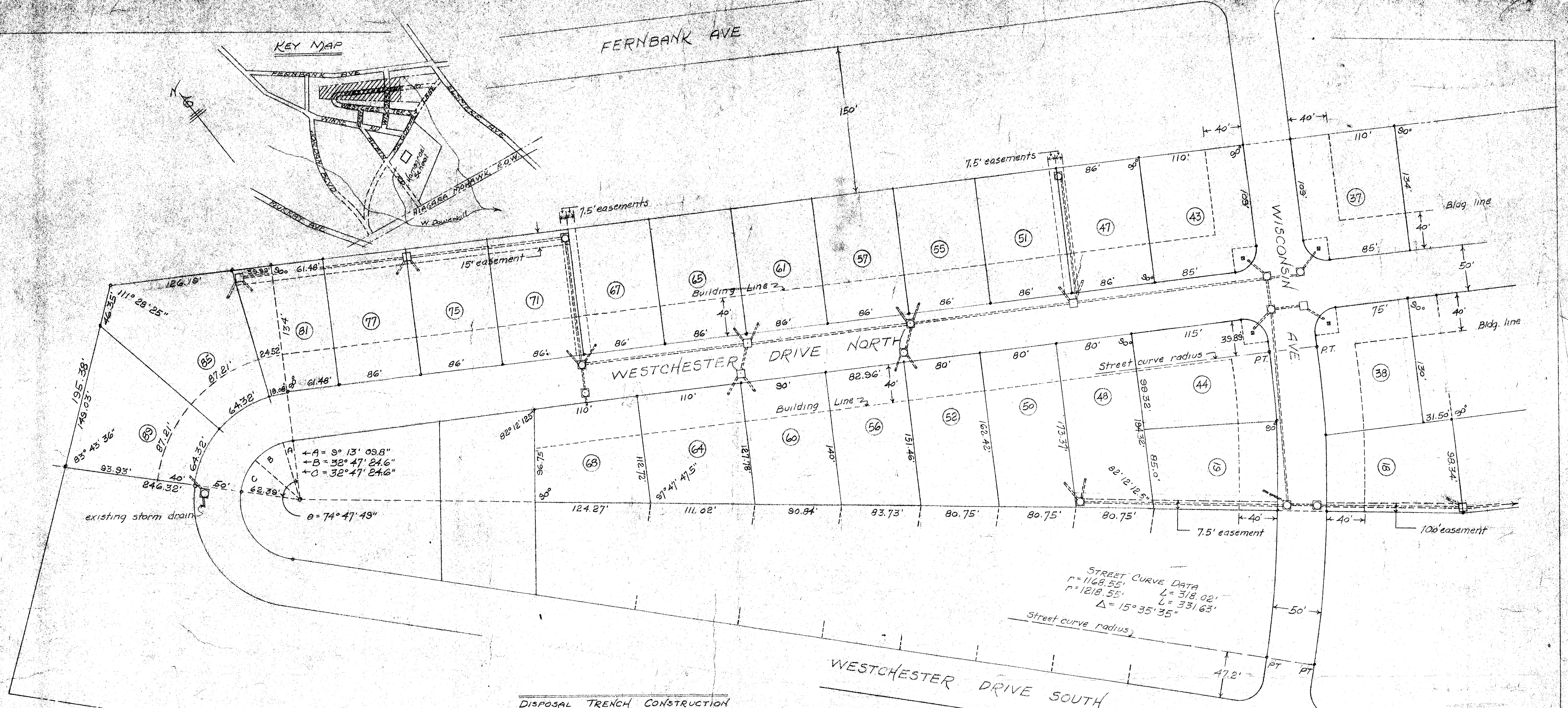

MAP NOTES

Lot numbers shown are street numbers.

Easements shown are to Town of Bethlehem.

Street radius equal 25', 90 degrees (A).

Stubs for house drain connections are 4" Orangeburg.

Catchbasins are indicated □

Drainage junction basins are indicated □

500 gal. tank required. Commercial tank may be used.

Baffles or tees optional.

Steel, schedul-3/8" φ - 2 @ 6', 5 @ 3' 4"

Scale: 3/8" = 1 ft.

SEPTIC TANK NOTES

Design of septic tank is based upon 4 living units.

Liquid capacity of septic tank shall be at least 1000 gallons.

Commercial standard steel tank 177-SI may be substituted for the concrete tank shown.

Line from house sewer and line between septic tank and distribution box shall be bell and spigot type vitrified, or concrete pipe, with water tight joints.

Disposal field shall not be located within 10' of dwellings, lot lines and large trees.

Soil tests were taken at present grades. Extensive grading would require new tests.

Grade of all tile lines shall be strictly adhered to.

It is suggested that for the most efficient operation of the sewage disposal system, any surface drainage be diverted from the disposal area.

Lot numbers to be used as house numbers.

Length of tile field based on 15 minute test.

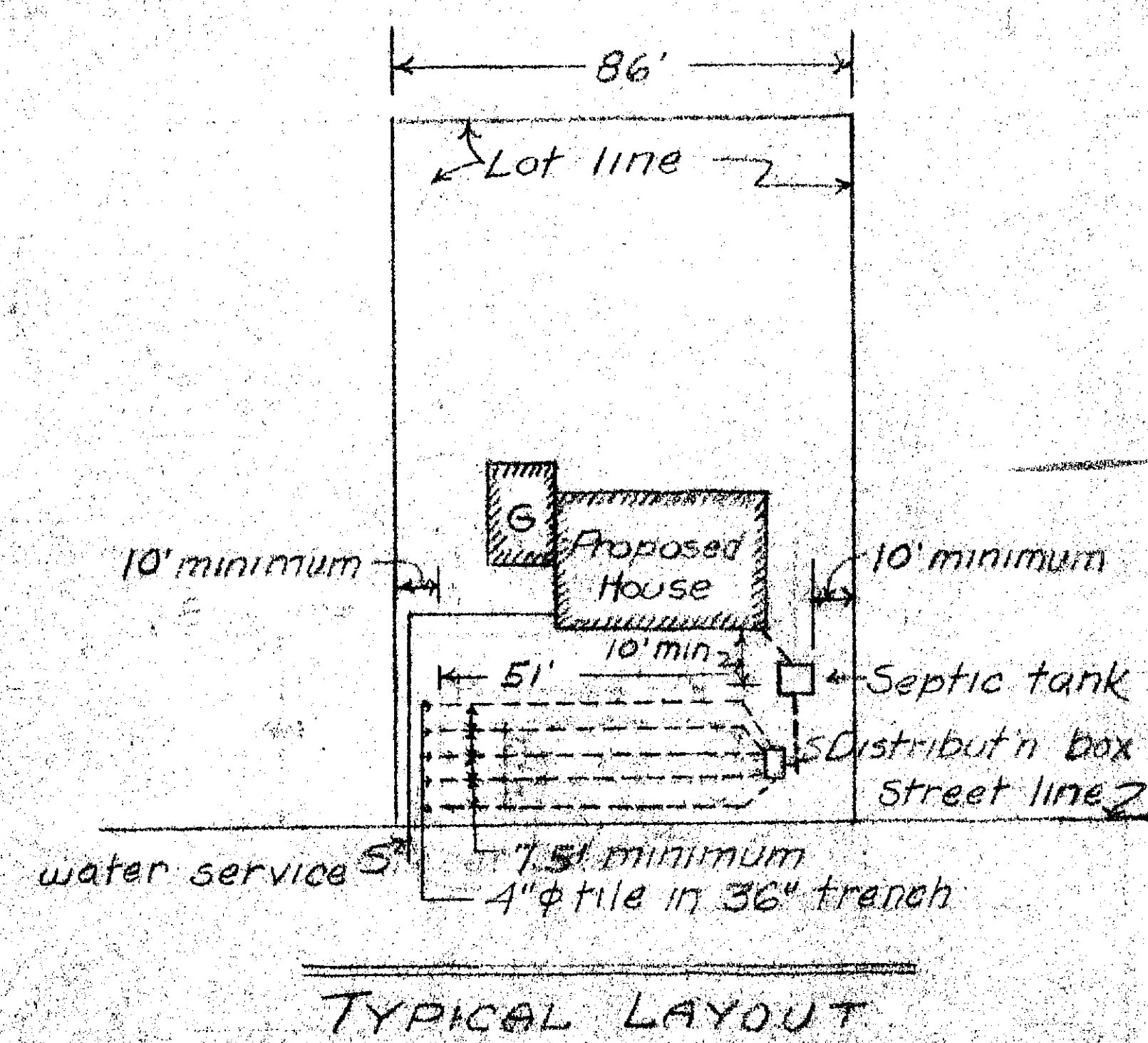

HAMAGRAEL
 MAP OF
 WESTCHESTER DRIVE NORTH
 SECTION A

PROPERTY OF
 FAYE O. & SIDNEY A. FRIEDMAN

ALBANY COUNTY DELMAR, N.Y.
 SCALE - 50 FT = 1 INCH JAN. 1961

DRAWN BY SIDNEY A. FRIEDMAN - P.E.

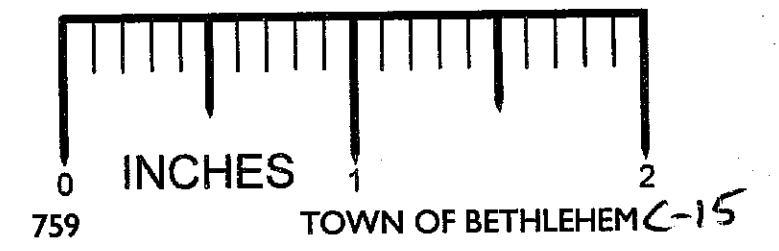

THE PLANNING BOARD
 TOWN OF BETHLEHEM - ALBANY CO., N. Y.

Has ~~not~~ approved the street layout as shown on this plan.

September 7, 1961.